

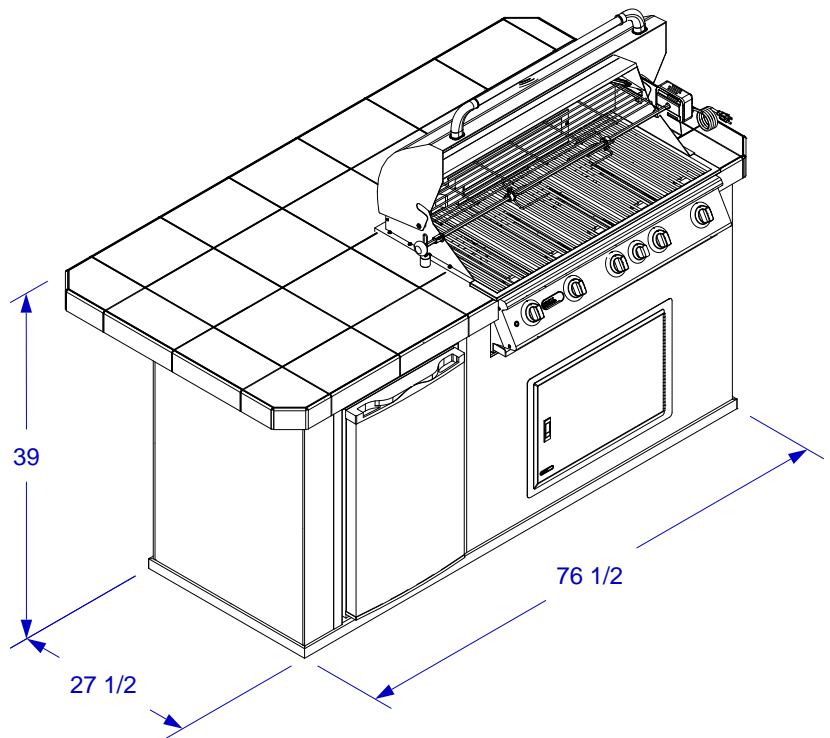

REVERSED POWER Q
ISLAND W/ 43" TOP,
BRAHMA GRILL &
FRIDGE SPEC SHEET

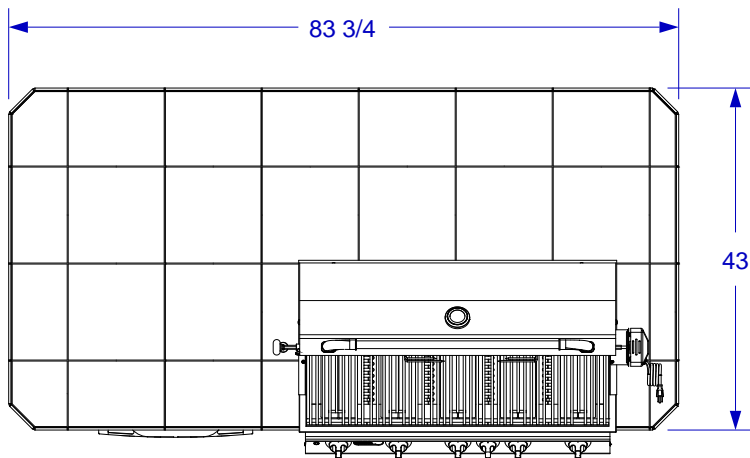

ISOMETRIC VIEW



TOP VIEW

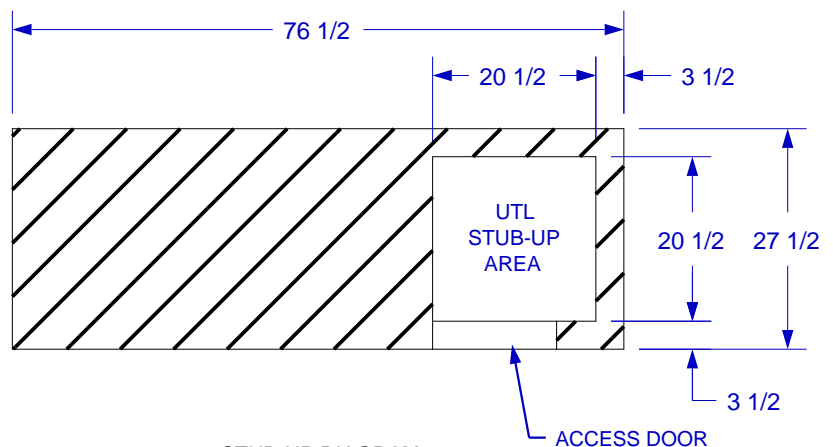

STUB-UP DIAGRAM
 (SEE NOTE #2)

- NOTES:**
1. FOR ROCK FINISHES, ADD 1 1/2" ON ALL BASE SIDES.
 2. 6" MAX HEIGHT ON ALL STUB-UPS.
 3. SHOWN WITH OPTIONAL 5-BURNER BRAHMA GRILL
 4. SCALE: 1/2" = 1'-0"